

(2) DCS Band Balun (SCI-102 W/F)

FEATURES

- Passive integration on silicon substrate
- Low insertion loss in pass band
- Small size: 0.8 mm x 1.1 mm (wirebond)
1.2 mm x 1.1 mm (flip chip)
- Pb-free solder bump
- Low profile: 0.25 mm height (wirebond)
0.40 mm height (flip chip)
- Directly attachable on PCB or flipped on PCB
- Operating temperature: -40°C to +85°C
- Storage temperature: -40°C to +85°C

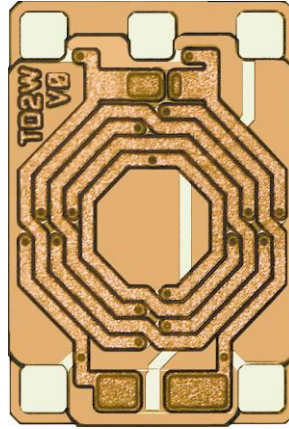

SCI-102W (Wirebond)

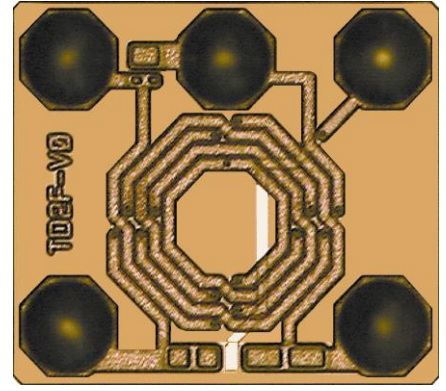

SCI-102F (Flip Chip)

DESCRIPTION

SCI-102W/F is a balun for DCS band applications. The balun has low pass-band insertion loss and small size. It is composed of thick copper inductors and Metal-Insulator-Metal capacitors which are fabricated on a silicon substrate using our IPD (Integrated Passive Device) process. The pad or bump size and pitch of the balun are selected so that the device can be mounted directly on a PCB or laminate substrate using conventional wirebonding or surface mount techniques. The low profile and small form-factor of the device make it especially suitable for SiP applications.

ELECTRICAL SPECIFICATIONS

Specification	Unit	Min.	Typical	Max.
Pass Band	MHz	1710		1980
Insertion Loss	dB		0.8	
Return Loss	dB	10		15
Differential Impedance	Ohm		100	
Amplitude Imbalance	dB	0.2		0.65
Phase Imbalance	deg		5.0	
Size	mm	0.8 x 1.1 (WB)		1.2 x 1.1 (FC)

DIMENSIONS

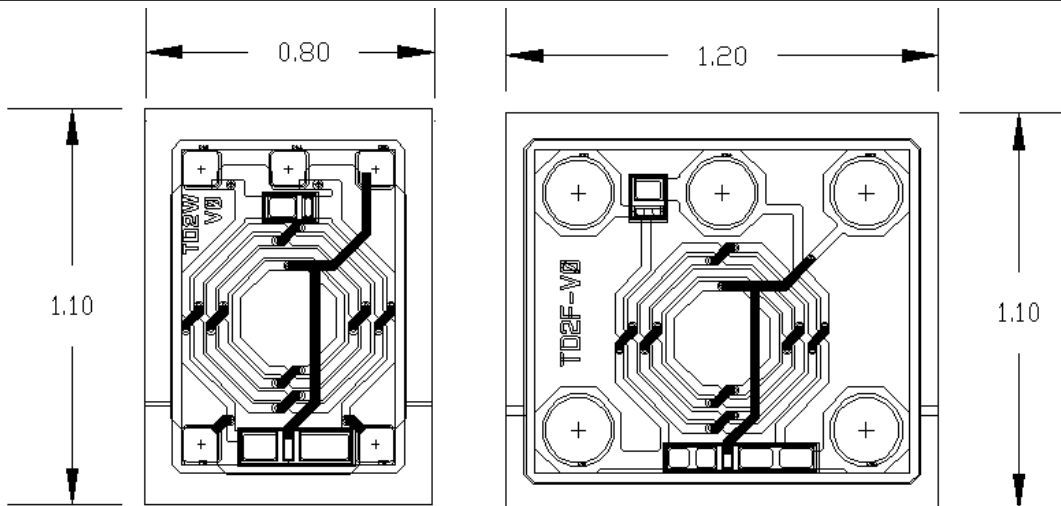

TYPICAL CHARACTERISTICS

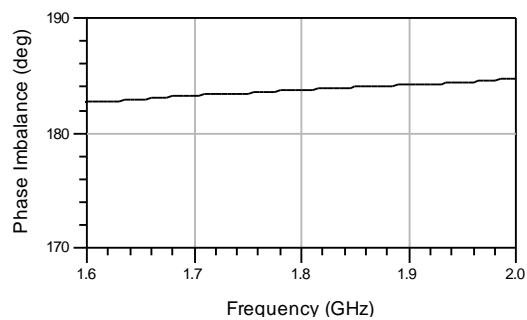
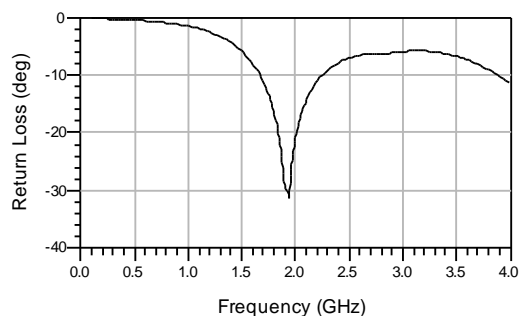
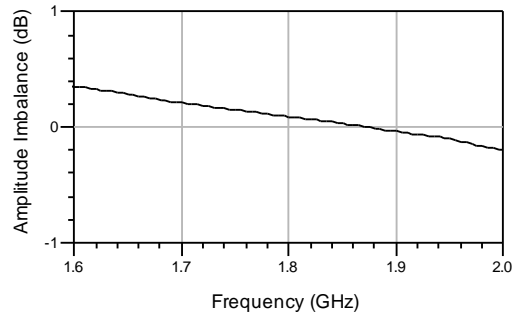
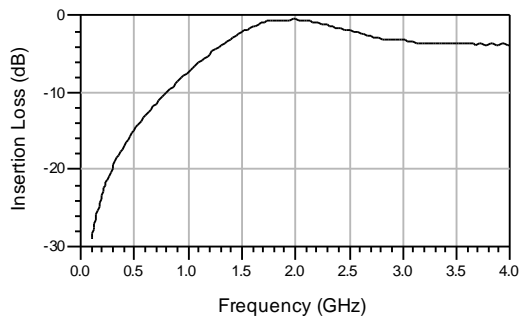

ASSEMBLY DRAWING / MECHANICAL OUTLINE

SCI-102W (Wirebond)

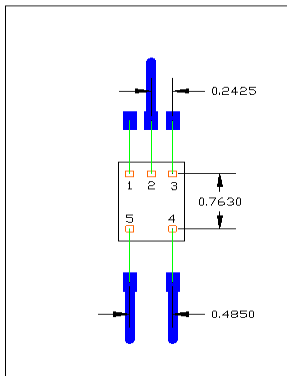

SCI-102F (Flip Chip)

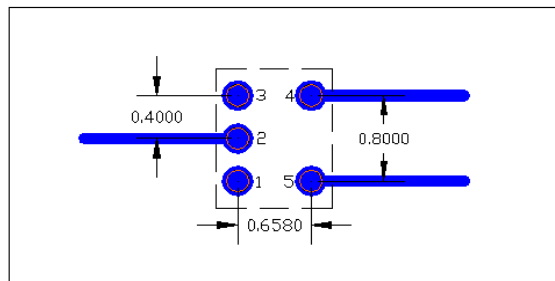

Pad	SCI-102W Signal	SCI-102F Signal
1	Ground	Bias
2	Unbalanced	Unbalanced
3	Bias	Ground
4	Balanced (-)	Balanced (+)
5	Balanced (+)	Balanced (-)

NOTES

All dimension measurement units are in millimeters (mm). Electrical performance and typical values are measured at room temperature. For best results, ground plane directly beneath the device should be in the top metal layer.

Refer to "Appendix A" for:

- Pad sizes and typical wirebond length used in the wirebonded IPD products.
- Recommended solder thermal profile, landing pattern recommendation and bump specifications used in the flip chip IPD products.