

(26) 802.11a Band Pass Filter (SCI-402 W/F)

FEATURES

- Passive integration on silicon substrate
- Low insertion loss in pass band
- Small size: 1.4 mm x 1.1 mm (wirebond)
1.5 mm x 1.2 mm (flip chip)
- Pb-free solder bump
- Low profile: 0.25 mm height (wirebond)
0.40 mm height (flip chip)
- Directly attachable on PCB or flipped on PCB
- Operating temperature: -40°C to +85°C
- Storage temperature: -40°C to +85°C

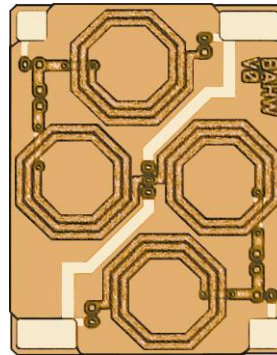

SCI-402W (Wirebond)

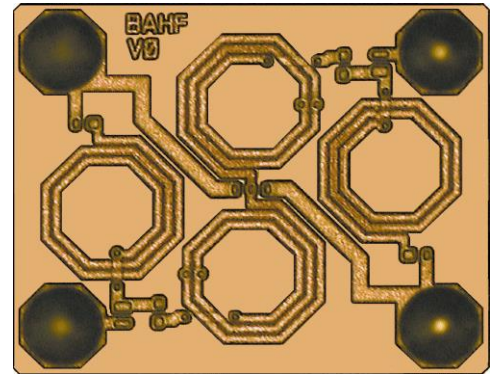

SCI-402F (Flip Chip)

DESCRIPTION

STATS ChipPAC's SCI-402W/F is a band pass filter (BPF) for 802.11a band applications. The BPF has low pass-band insertion loss and small size. It is composed of thick copper inductors and Metal-Insulator-Metal capacitors which are fabricated on a silicon substrate using our IPD (Integrated Passive Device) process. The pad or bump size and pitch of the BPF are selected so that the device can be mounted directly on a PCB or laminate substrate using conventional wirebonding or surface mount techniques. The low profile and small form-factor of the device make it especially suitable for SiP applications.

ELECTRICAL SPECIFICATIONS

Specification	Unit	Min.	Typical	Max.
Pass Band	MHz	5115		5825
Insertion Loss	dB		1.0	
Return Loss	dB		15	
Attenuation, 2450 MHz	dB		40	
Attenuation, 1100 MHz	dB		40	
Size	mm	1.4 x 1.1 (WB)		1.5 x 1.2 (FC)

DIMENSIONS

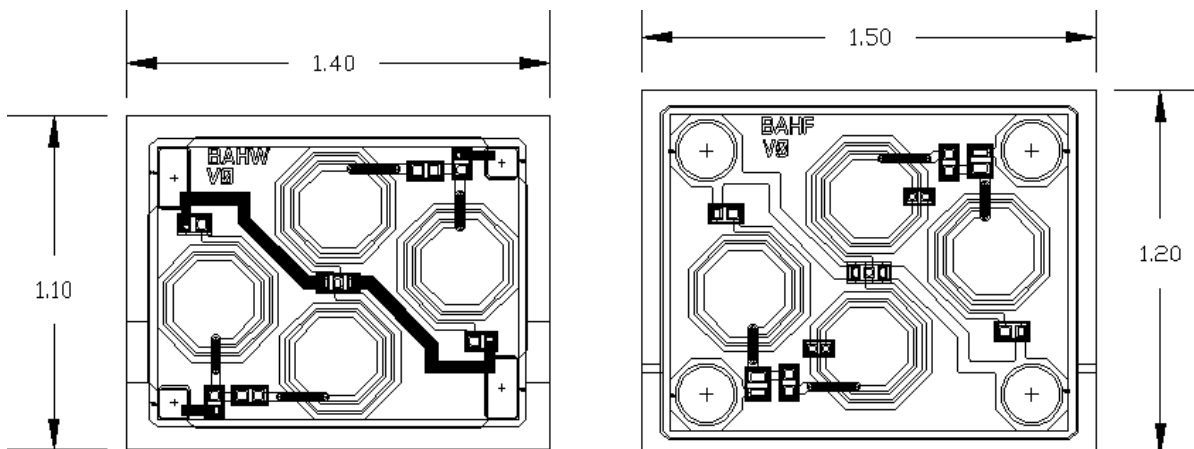

TYPICAL CHARACTERISTICS

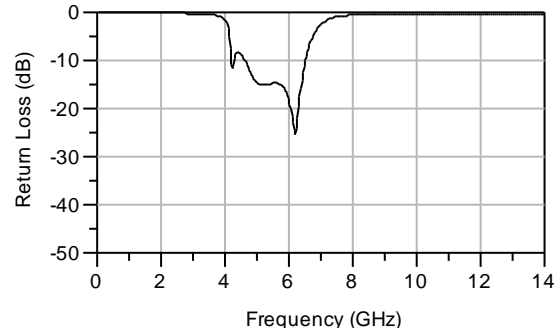
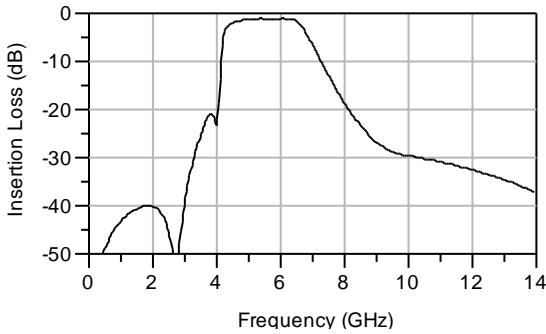

ASSEMBLY DRAWING / MECHANICAL OUTLINE

SCI-402W (Wirebond)

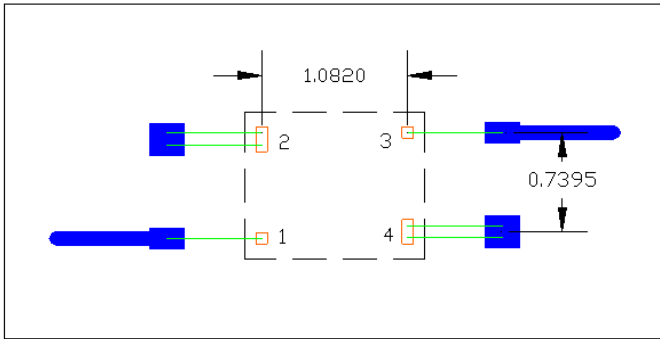

SCI-402F (Flip Chip)

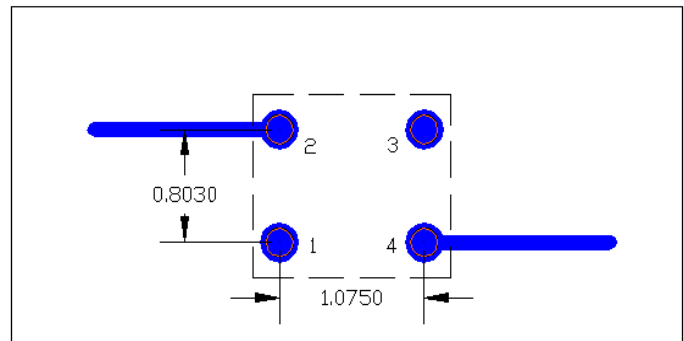

Pad	SCI-402W Signal	SCI-402F Signal
1	Input	Ground
2	Ground	Output
3	Output	Ground
4	Ground	Input

NOTES

All dimension measurement units are in millimeters (mm). Electrical performance and typical values are measured at room temperature. For best results, ground plane directly beneath the device should be in the top metal layer.

Refer to "Appendix A" for:

- Pad sizes and typical wirebond length used in the wirebonded IPD products.
- Recommended solder thermal profile, landing pattern recommendation and bump specifications used in the flip chip IPD products.