

(33) DCS Band Loss Pass Filter with Coupler (SCI-702 W/F)

FEATURES

- Passive integration on silicon substrate
- Low insertion loss in pass band
- Small size: 1.0 mm x 1.2 mm (wirebond)
1.4 mm x 1.2 mm (flip chip)
- Pb-free solder bump
- Low profile: 0.25 mm height (wirebond)
0.40 mm height (flip chip)
- Directly attachable on PCB or flipped on PCB
- Operating temperature: -40°C to +85°C
- Storage temperature: -40°C to +85°C

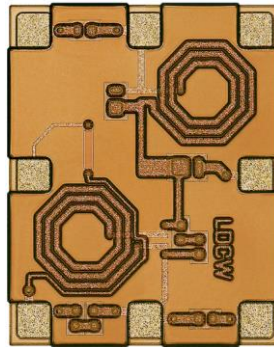

SCI-702W (Wirebond)

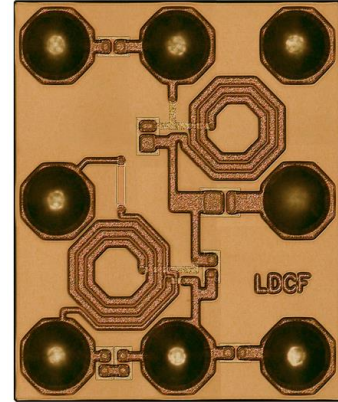

SCI-702F (Flip Chip)

DESCRIPTION

STATS ChipPAC's SCI-702W/F is a low pass filter with coupler for WiMax band applications. The IPD has low pass-band insertion loss and small size. It is composed of thick copper inductors and Metal-Insulator-Metal capacitors which are fabricated on a silicon substrate using our IPD (Integrated Passive Device) process. The pad or bump size and pitch of the IPD are selected so that the device can be mounted directly on a PCB or laminate substrate using conventional wirebonding or surface mount techniques. The low profile and small form-factor of the device make it especially suitable for SiP applications.

ELECTRICAL SPECIFICATIONS

(Test board loss 0.07 dB included)

Specification	Unit	Min.	Typical	Max.
Pass Band	MHz	1710		1980
Insertion Loss	dB			0.9
Return Loss	dB	20		
Attenuation, 2f ₀	dB	25		
Attenuation, 3f ₀	dB	25		
Coupling Coefficient	dB		-20	
Directivity (S31-S32)	dB		12	
Size	mm	1.0 x 1.2 (WB)		1.4 x 1.2 (FC)

DIMENSIONS

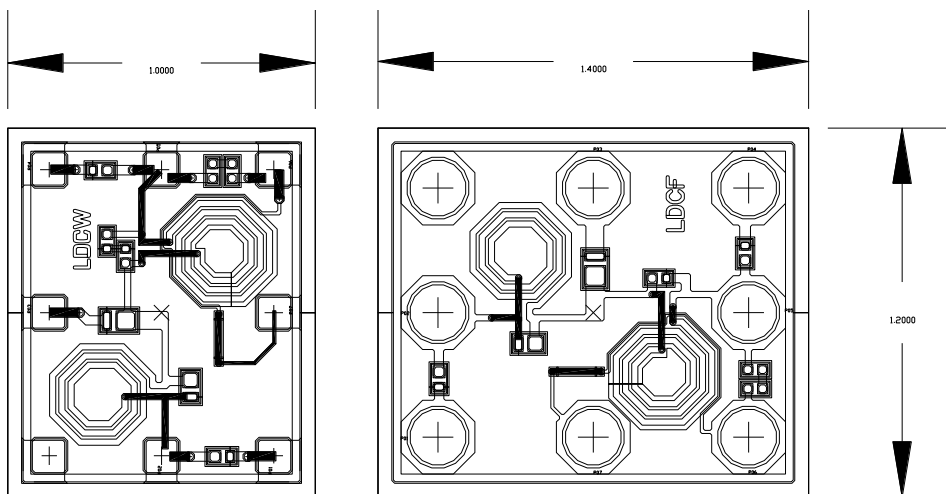

TYPICAL CHARACTERISTICS

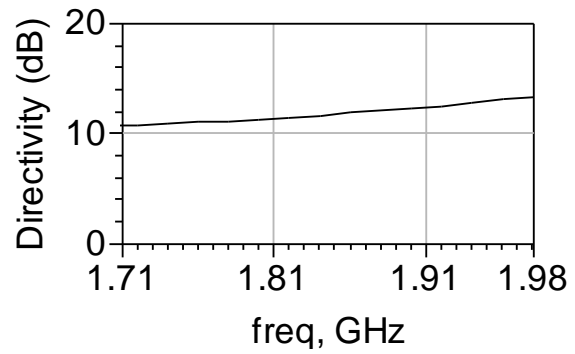
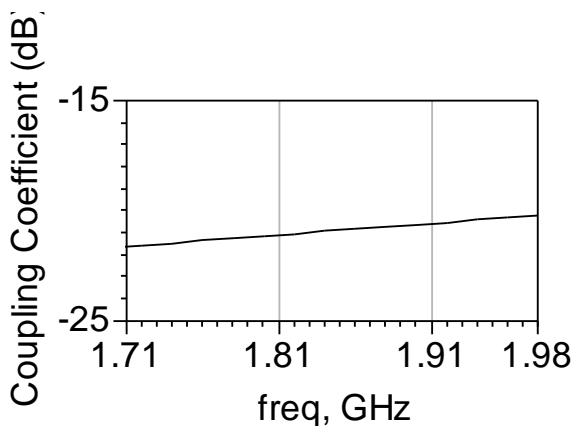
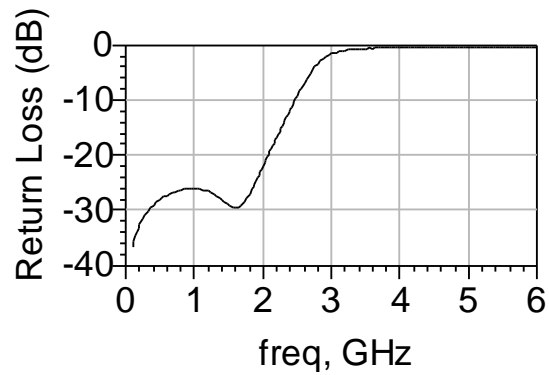
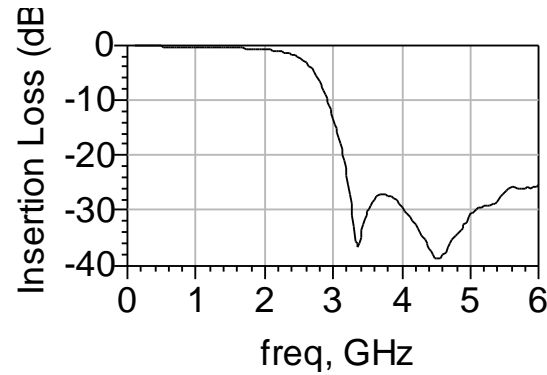

TEST BOARD DRAWING

SCI-702W (Wirebond)

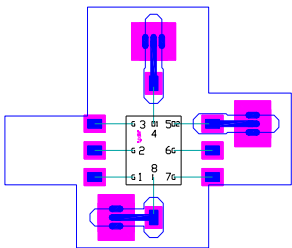

SCI-702F (Flip Chip)

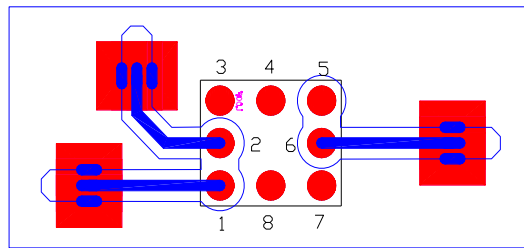

Pad	SCI-702W Signal	SCI-702F Signal
1	GND	Coupling
2	GND	Output
3	GND	GND
4	Output	GND
5	Coupling	NC
6	GND	Input
7	GND	GND
8	Input	GND

NOTES

All dimension measurement units are in millimeters (mm). Electrical performance and typical values are measured at room temperature. For best results, ground plane directly beneath the device should be in the top metal layer.

Refer to "Appendix A" for:

- Pad sizes and typical wirebond length used in the wirebonded IPD products.
- Recommended solder thermal profile, landing pattern recommendation and bump specifications used in the flip chip IPD products.