

## (22) 802.11b/g Band Pass Filter (SCI-305 W/F)

### FEATURES

- Passive integration on silicon substrate
- Low insertion loss in pass band
- Small size: 1.5 mm x 1.1 mm (wirebond)  
1.7 mm x 1.2 mm (flip chip)
- Pb-free solder bump
- Low profile: 0.25 mm height (wirebond)  
0.40 mm height (flip chip)
- Directly attachable on PCB or flipped on PCB
- Operating temperature: -40°C to +85°C
- Storage temperature: -40°C to +85°C

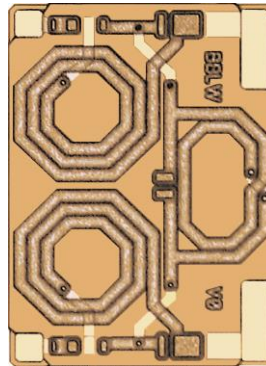

SCI-305W (Wirebond)

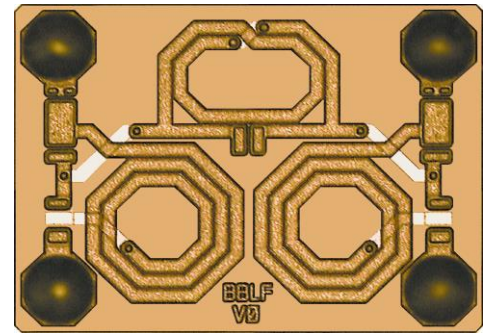

SCI-305F (Flip Chip)

### DESCRIPTION

STATS ChipPAC's SCI-305W/F is a band pass filter (BPF) for 802.11b/g band applications. The BPF has low pass-band insertion loss and small size. It is composed of thick copper inductors and Metal-Insulator-Metal capacitors which are fabricated on a silicon substrate using our IPD (Integrated Passive Device) process. The pad or bump size and pitch of the BPF are selected so that the device can be mounted directly on a PCB or laminate substrate using conventional wirebonding or surface mount techniques. The low profile and small form-factor of the device make it especially suitable for SiP applications.

### ELECTRICAL SPECIFICATIONS

Specification	Unit	Min.	Typical	Max.
Pass Band	MHz	2400		2500
Insertion Loss	dB	1.2		1.4
Return Loss	dB		20	
Attenuation, 900 MHz	dB		60	
Attenuation, 1900 MHz	dB		20	
Attenuation, 4800 MHz	dB		20	
Size	mm	1.5 x 1.1 (WB)		1.7 x 1.2 (FC)

### DIMENSIONS

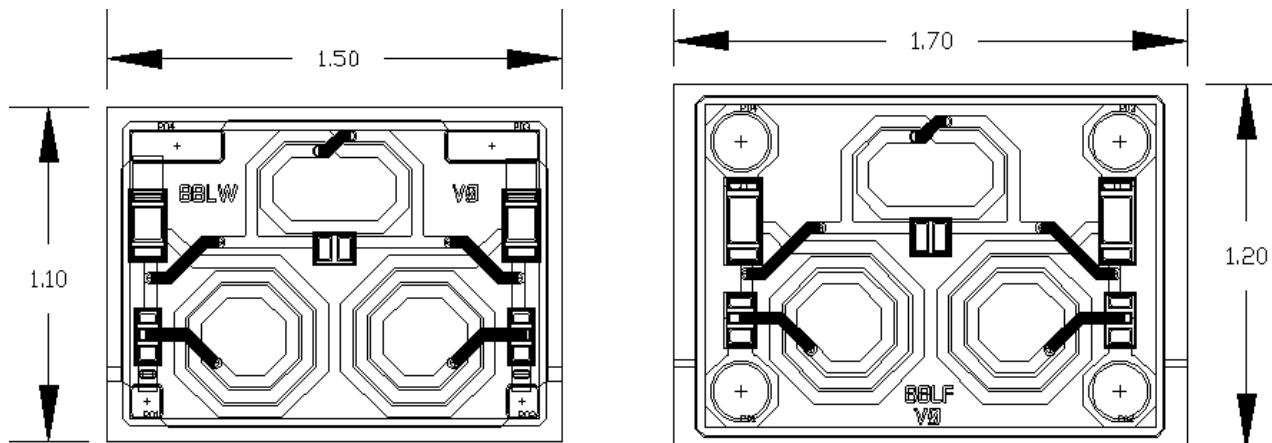

## TYPICAL CHARACTERISTICS

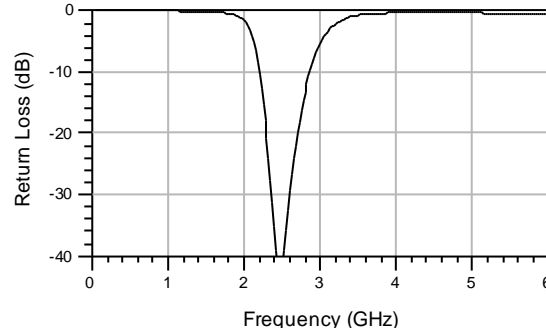
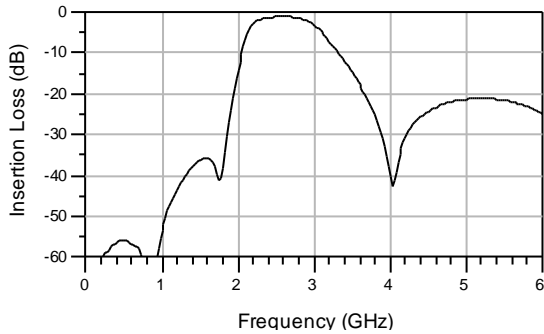

## ASSEMBLY DRAWING / MECHANICAL OUTLINE

### SCI-305W (Wirebond)

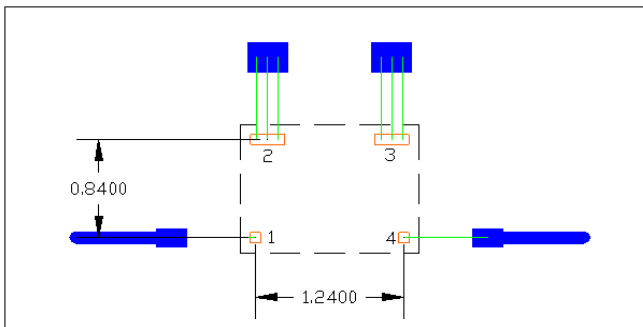

### SCI-305F (Flip Chip)

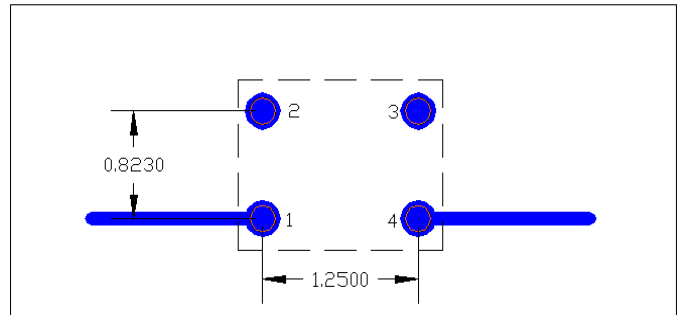

Pad	SCI-305W Signal	SCI-305F Signal
1	Input	Output
2	Ground	Ground
3	Ground	Ground
4	Output	Input

## NOTES

All dimension measurement units are in millimeters (mm). Electrical performance and typical values are measured at room temperature. For best results, ground plane directly beneath the device should be in the top metal layer.

Refer to "Appendix A" for:

- Pad sizes and typical wirebond length used in the wirebonded IPD products.
- Recommended solder thermal profile, landing pattern recommendation and bump specifications used in the flip chip IPD products.